

Kinderganderobe

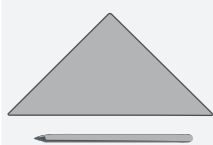

GEREEDSCHAPSVORSTEL:



potlood & liniaal



plakband



schaar



figuurzaag



schuurpapier



toffelzaag



houtlijm



schroeven- draaier



boortje
Ø 3 & 8 mm

NAAM:

GROEP/KLAS:

INHOUD:

AFMETINGEN:

ONDERDELEN:

INHOUD:	OK✓	AFMETINGEN:	ONDERDELEN:
1 grenen lat	<input type="checkbox"/>	260 x 25 x 10 mm	D
1 grenen lat	<input type="checkbox"/>	380 x 15 x 15 mm	E, F
5 grenen latten	<input type="checkbox"/>	340 x 20 x 15 mm	G
1 rondhoutje Ø 8 mm	<input type="checkbox"/>	260 mm	
1 triplex plaat	<input type="checkbox"/>	310 x 150 x 10 mm	A, H
2 triplex plaatjes	<input type="checkbox"/>	135 x 50 x 10 mm	B
2 triplex plaatjes	<input type="checkbox"/>	145 x 50 x 6 mm	C, J
8 houtschroeven	<input type="checkbox"/>	3 x 20 mm	
4 houtschroeven	<input type="checkbox"/>	3 x 30 mm	

1 Overzicht:

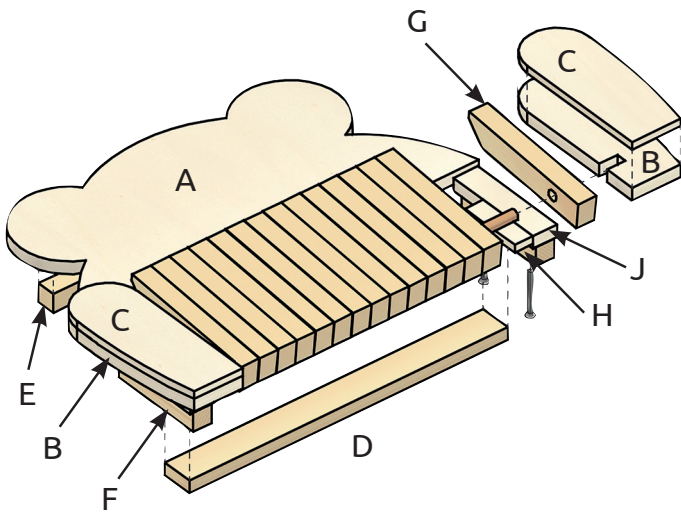

Verschaf jezelf een eerste overzicht.



2 De delen (A, B, C, H, J):

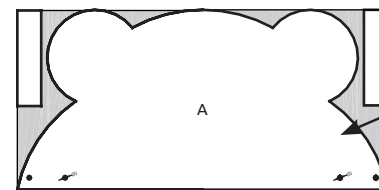
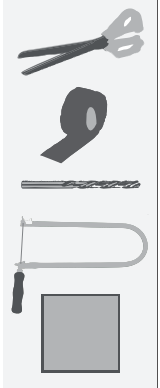
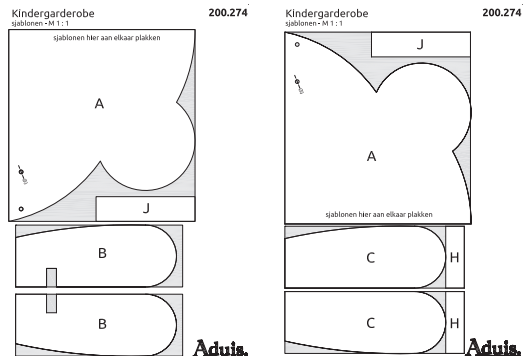

sjablonen aan elkaar plakken

Knip de sjablonen voor de triplex delen (A, B, C, H, J) grof met de schaar uit en plak ze met plakband op de triplex delen. **Sjabloon voor deel (A) aan elkaar plakken!** Boor de gaten $\varnothing 3$ mm zoals aangegeven. Zaag de delen met de figuurzaag uit en schuur alle randen en vlakken met schuurpapier na.



3 Delen (G):

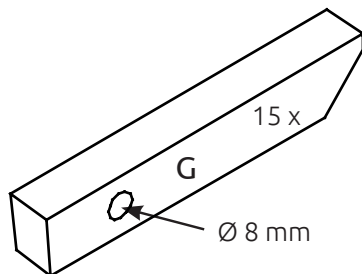
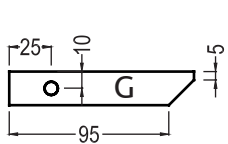
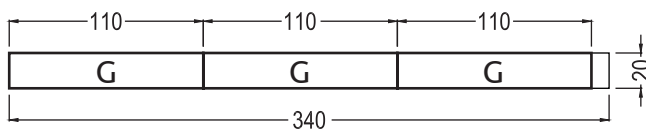
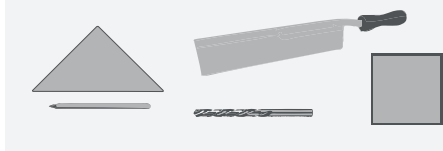

Breng de maten over op de latten.

Zaag de 5 grenen latten op de juiste maat af. Boor in de **15 ontstane latten** steeds een gat met $\varnothing 8$ mm en zaag ze volgens de afbeelding in de juiste vorm. Werk de latten met schuurpapier na.



4 De resterende houten latten:

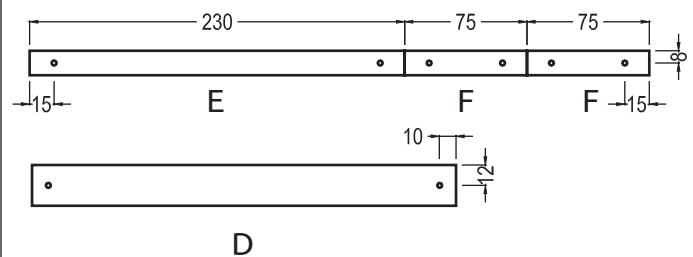
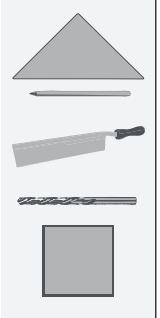

Teken de afmetingen op de latten.

Zaag de delen (E, F) op maat.

Boor de gaten $\varnothing 3$ mm zoals aangegeven in de delen (E, F en D).

Werk de onderdelen met schuurpapier na.



5 Het in elkaar zetten:

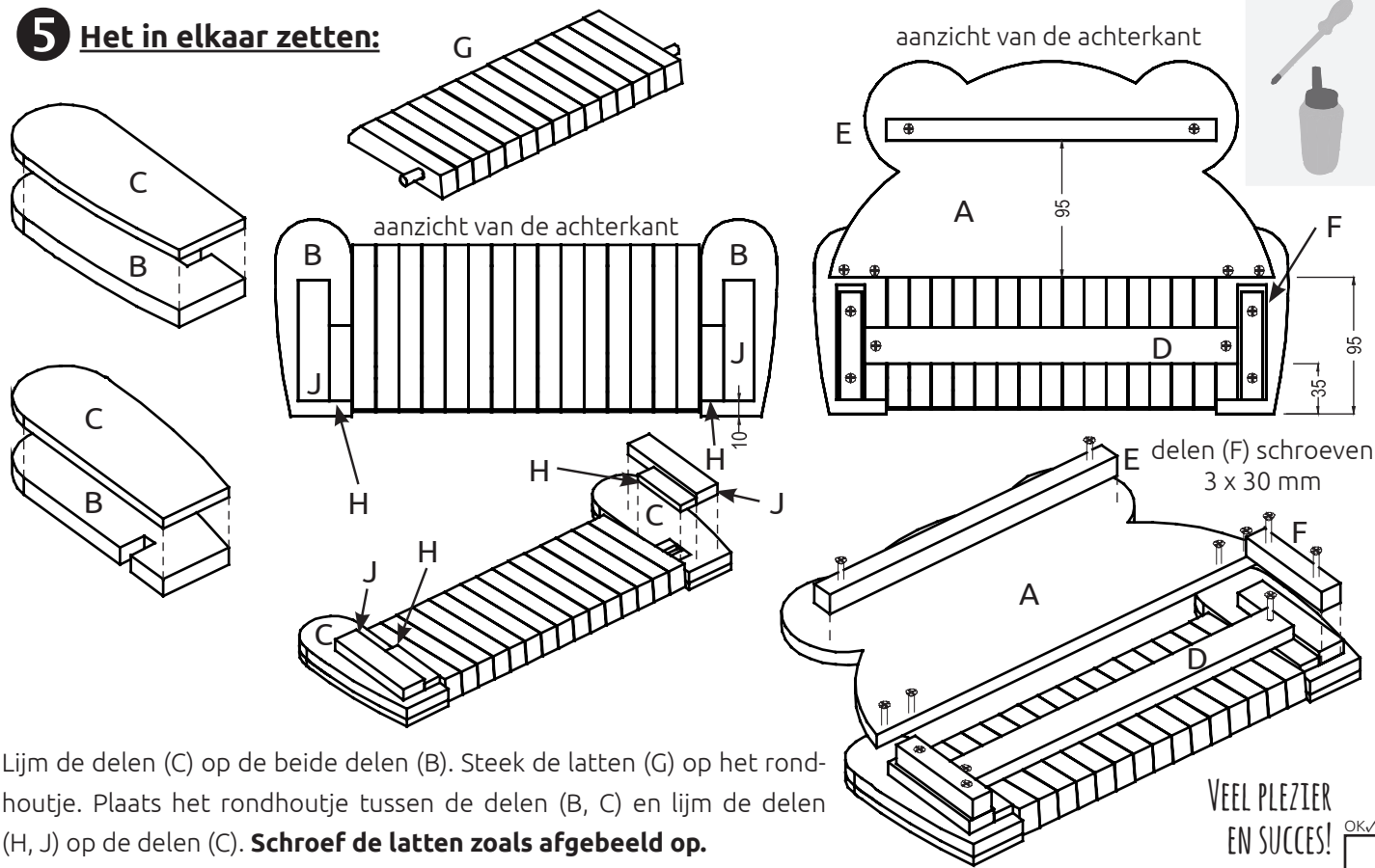

Lijm de delen (C) op de beide delen (B). Steek de latten (G) op het rondhoutje. Plaats het rondhoutje tussen de delen (B, C) en lijm de delen (H, J) op de delen (C). **Schroef de latten zoals afgebeeld op.**

De TEC+ opdracht



- 1** Je kindergarderobe is nu klaar. De gebouwde variant is gemaakt als hangend model. Ken je nog andere manieren, waarop je je garderobe op kunt **hangen c.q. bevestigen**?
- 2** Denk samen met je klasgenoten na over de verschillende manieren op welke voorwerpen kunnen worden gemonteerd. **Bespreek je suggesties in de groep.**

Eén van de vele oplossingen vindt je op www.aduis.com!

Kindergarderobe

sjablonen - M 1 : 1

200.274

sjablonen hier aan elkaar plakken

A

J

B

B

Aduis.

Kindergarderobe

sjablonen - M 1 : 1

200.274

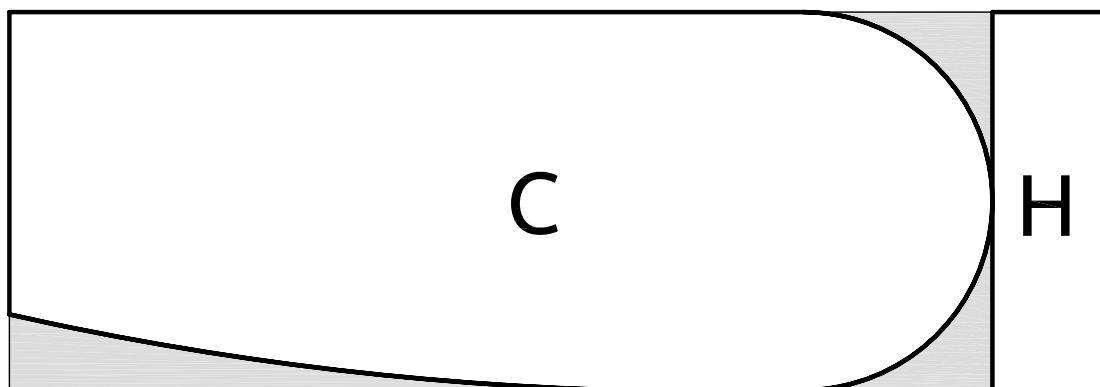
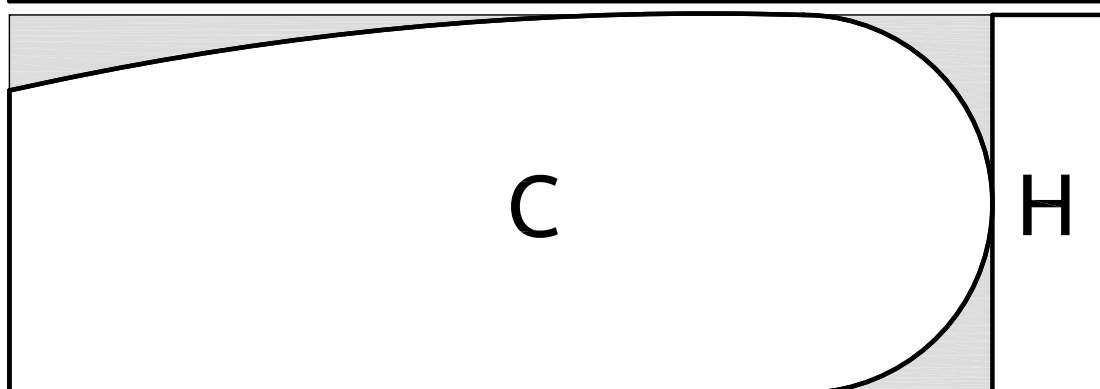
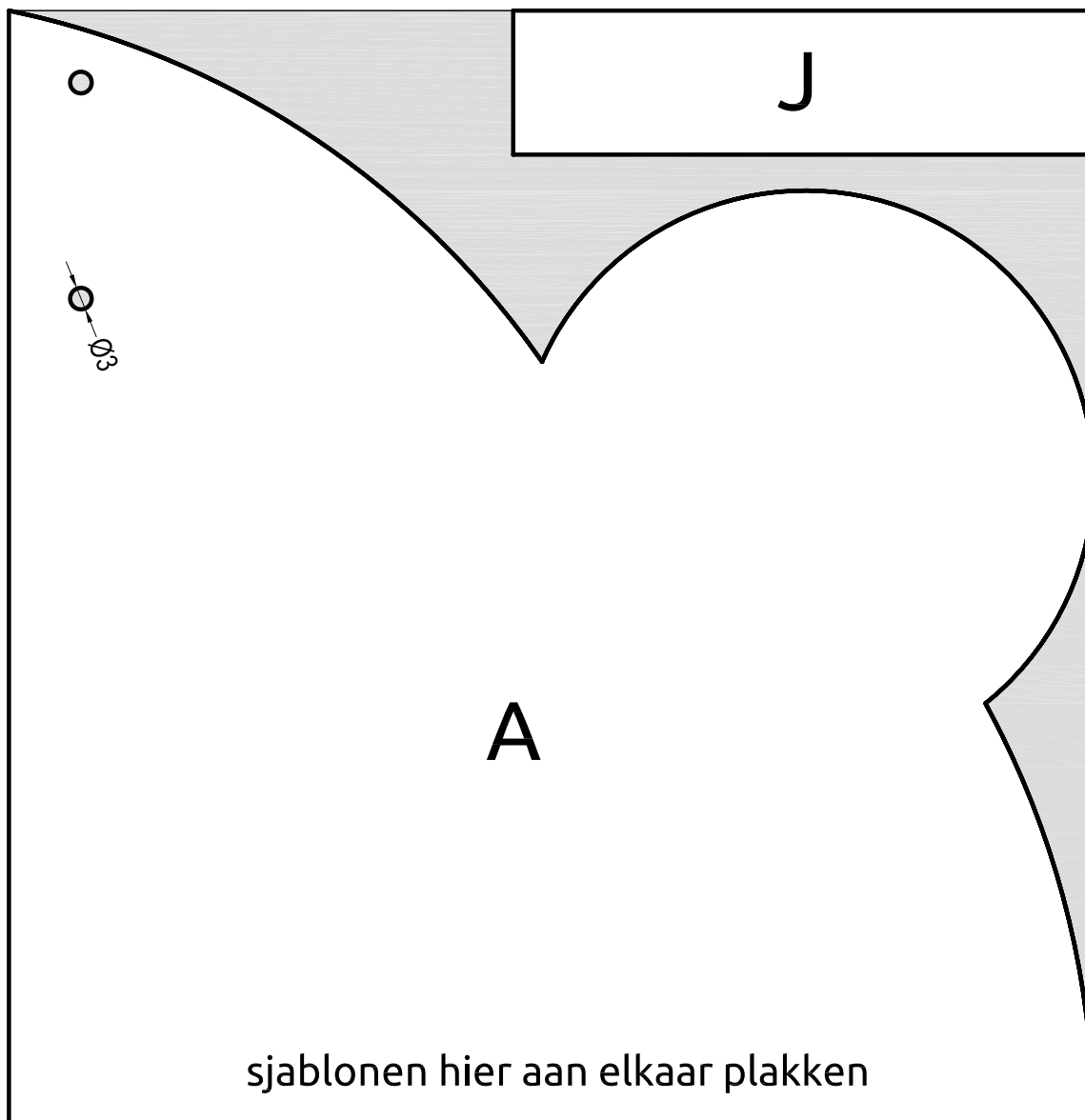

Aduis.